

Article number: 20343640M1263KS

Description: E+G levelling foot
GN 343.6-40-M12-63-KS

Measures

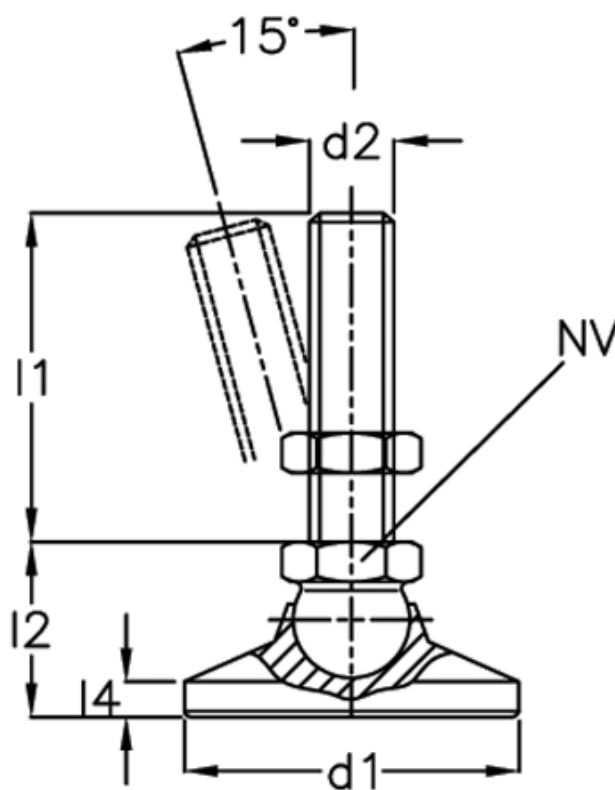

A/F	= 17
d1	= 40
d2	= 12
l1	= 63
l2	= -
l4	= -
Static load (N)	= 16
Weight in (g)	= 175